

Инструкция по установке

SKODA KAROQ

(2020-)

SKODA KODIAQ

(2017-)

VOLKSWAGEN TIGUAN

(2016-)



Арт.: F.5111.001

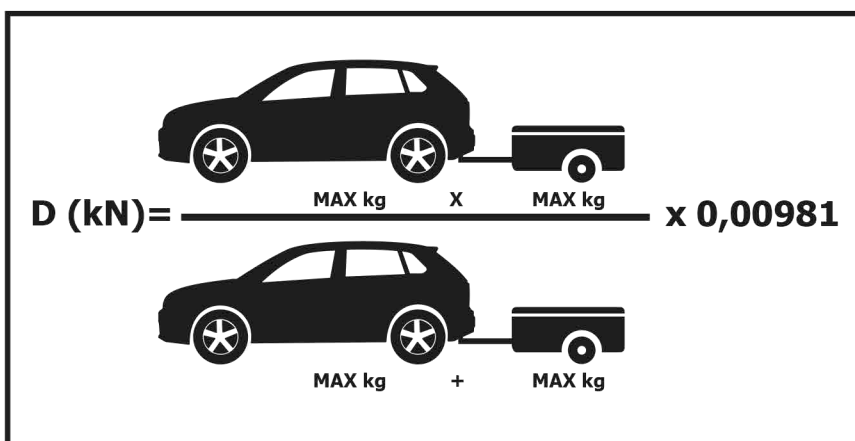
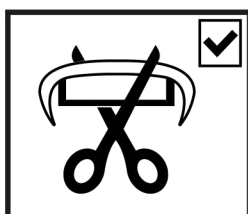
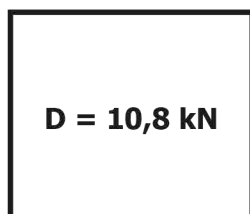
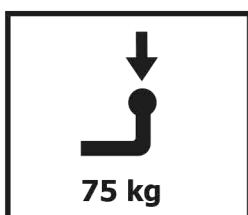
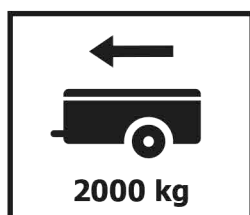

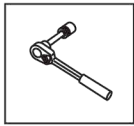

Вкрутить/выкрутить используя инструмент

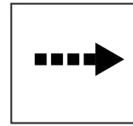

Движение

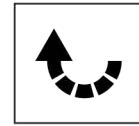

Поворот



Вкрутить/выкрутить не затягивая

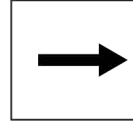





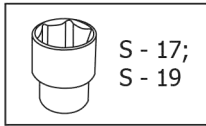
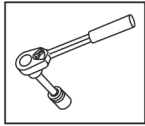

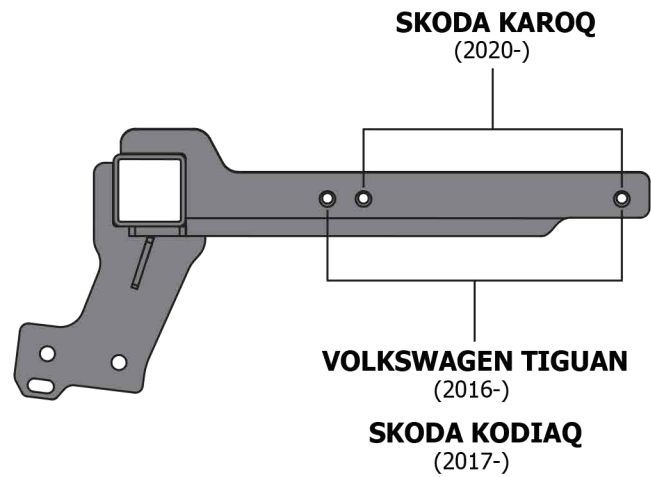
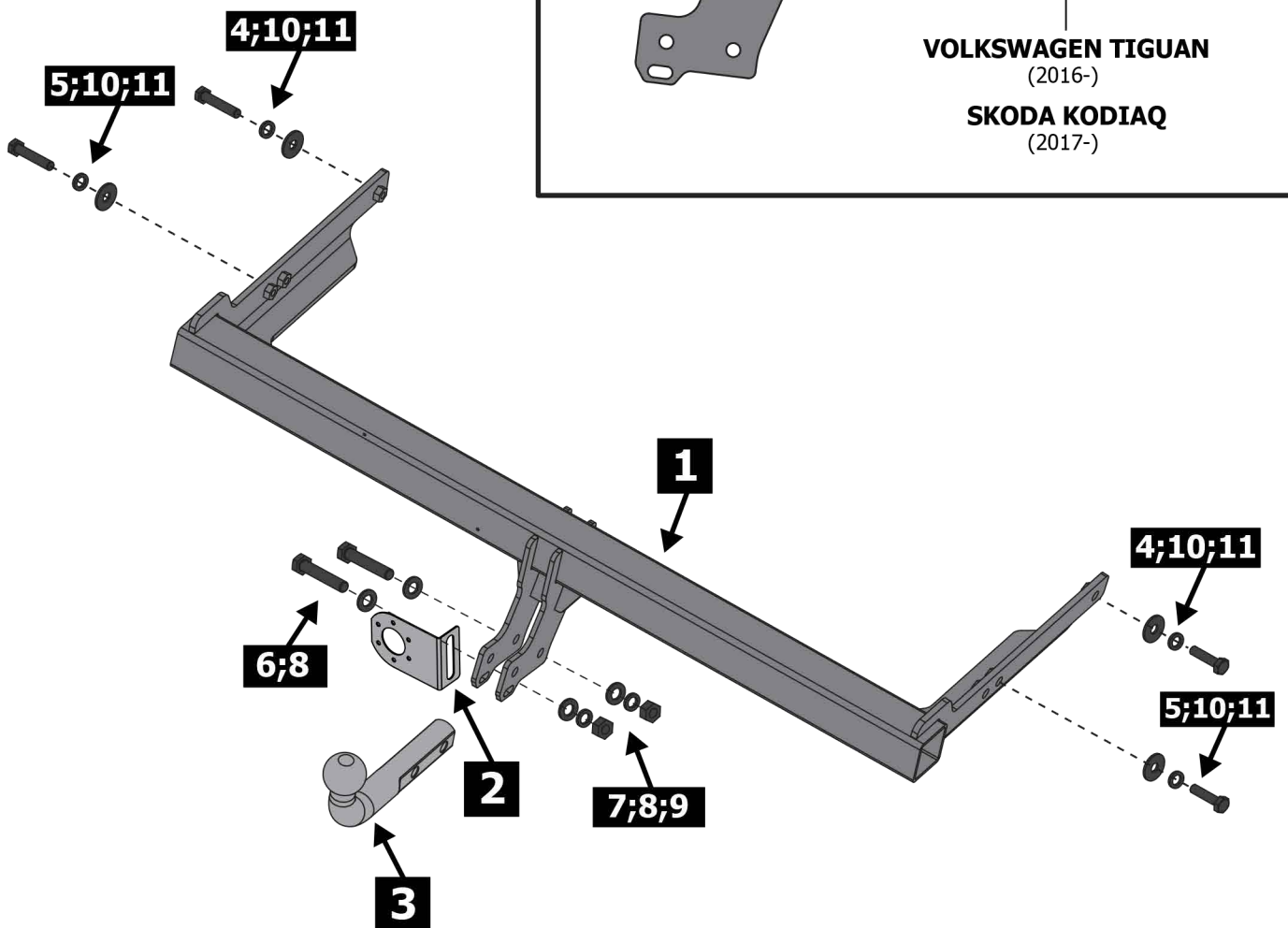

Расположение

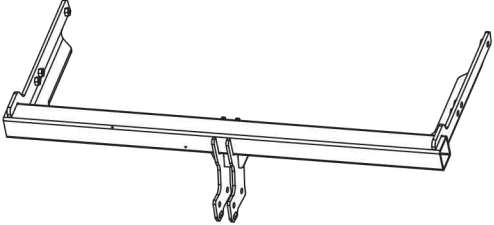
Используемый инструмент:

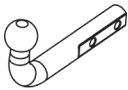
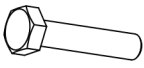
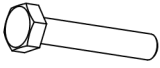

S - 17;
S - 19

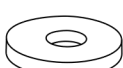

1	x1	Балка	
2	x1	Подрозетник	
3	x1	Крюк	
4	x2	M10x40	
5	x2	M10x50	
6	x2	M12x1.25x70	
7	x2	M12x1.25	
8	x4	∅ 12	
9	x2	∅ 12	
10	x4	∅ 10	
11	x4	∅ 10	

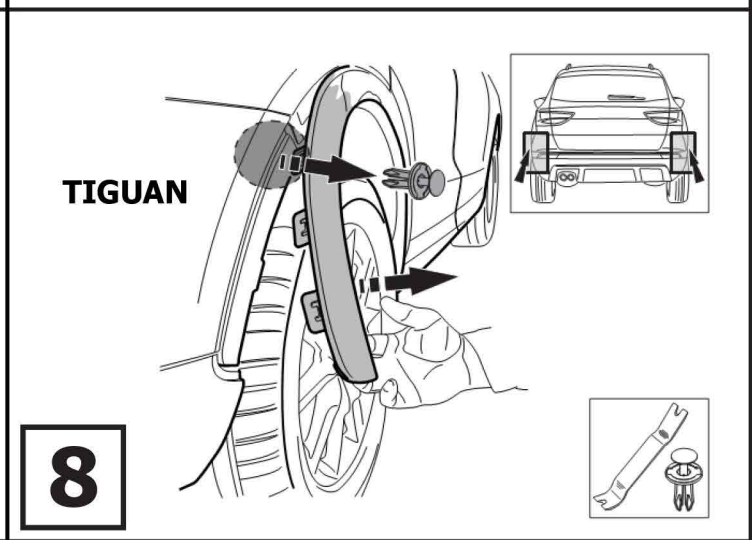
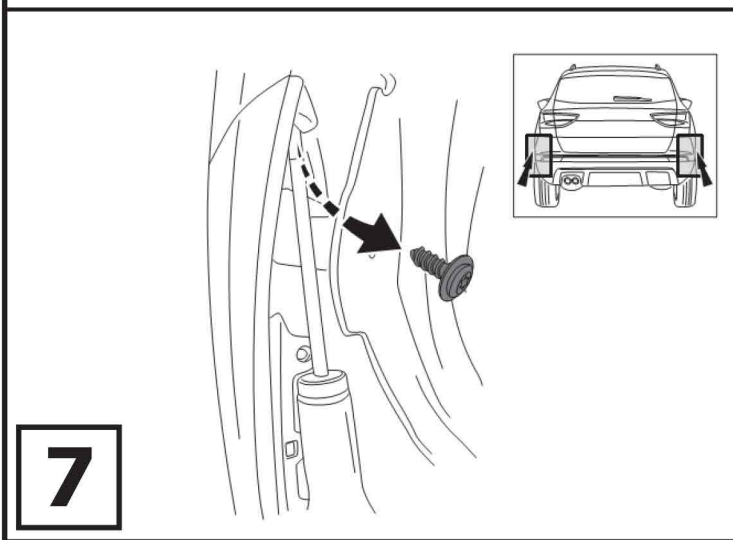
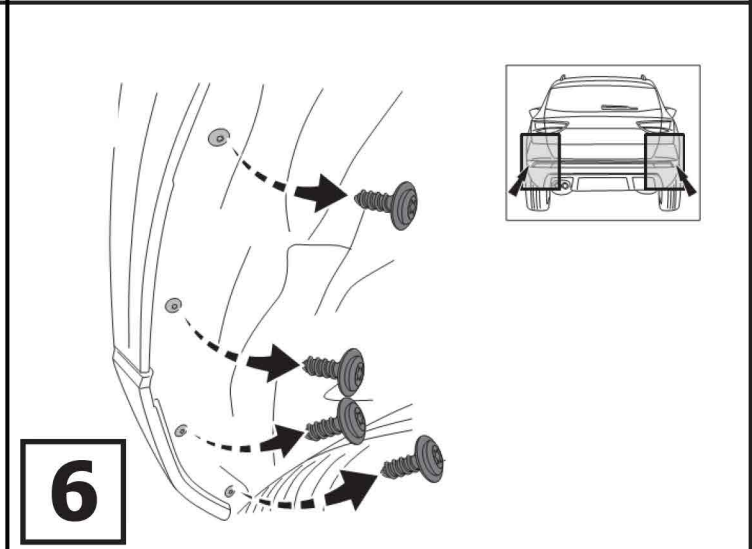
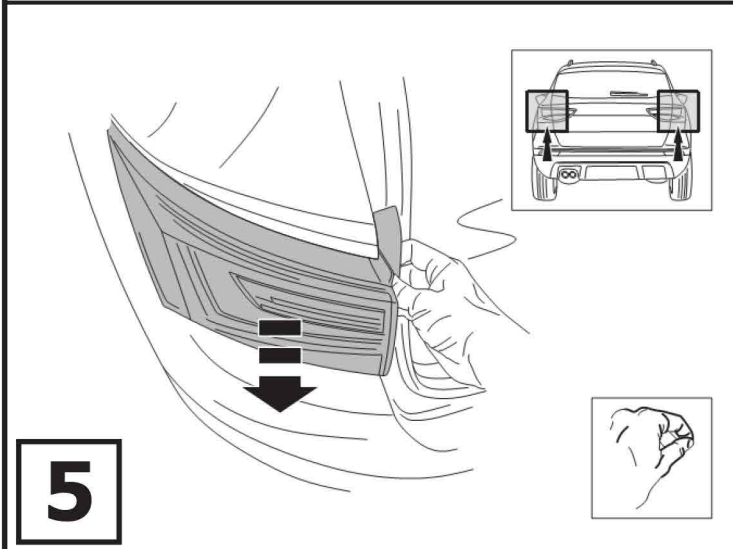
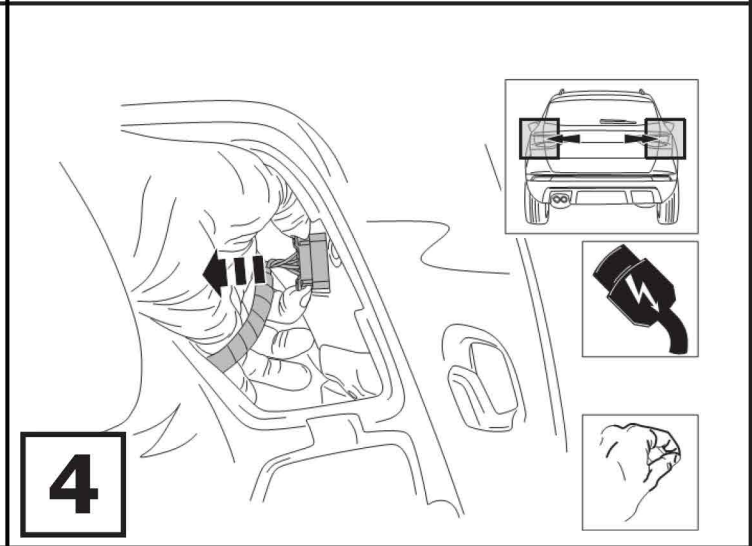
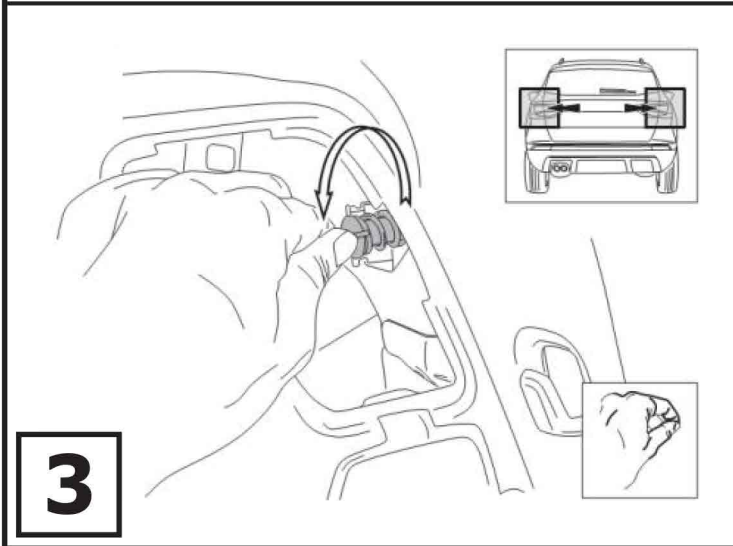
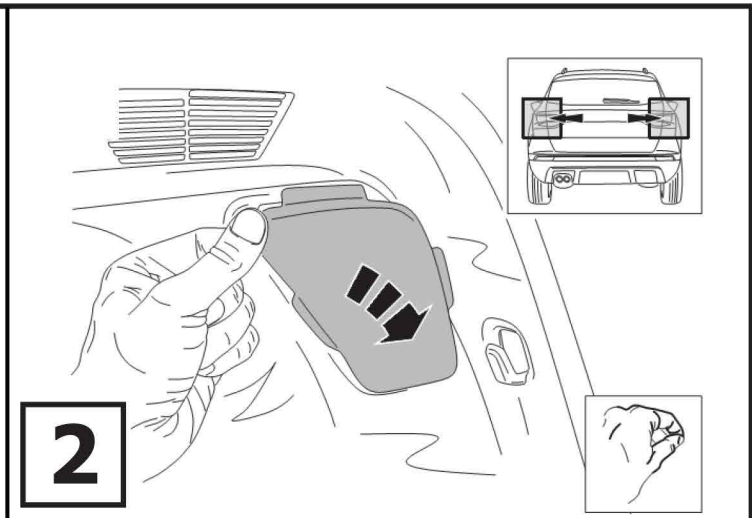
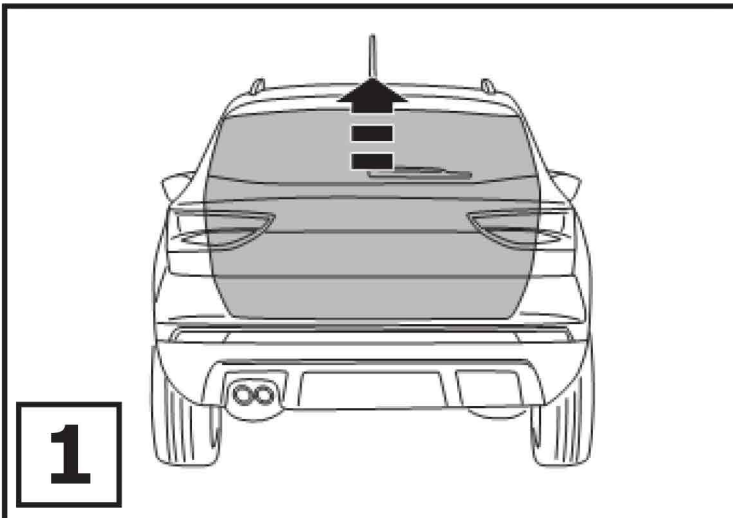

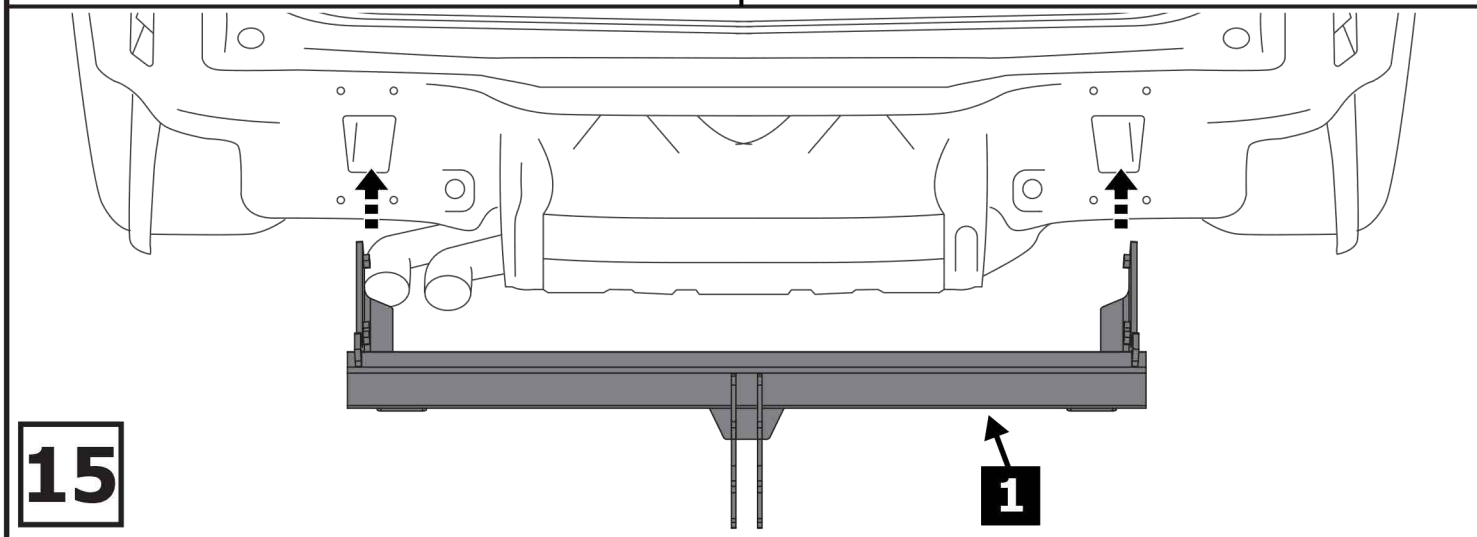
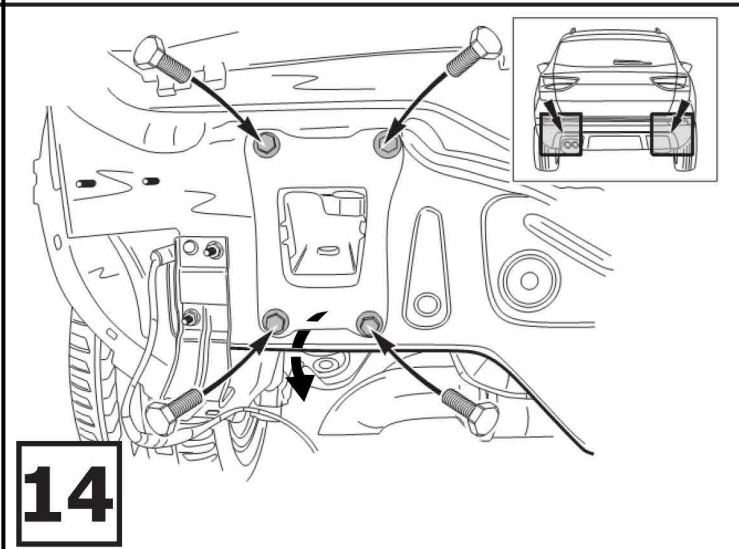
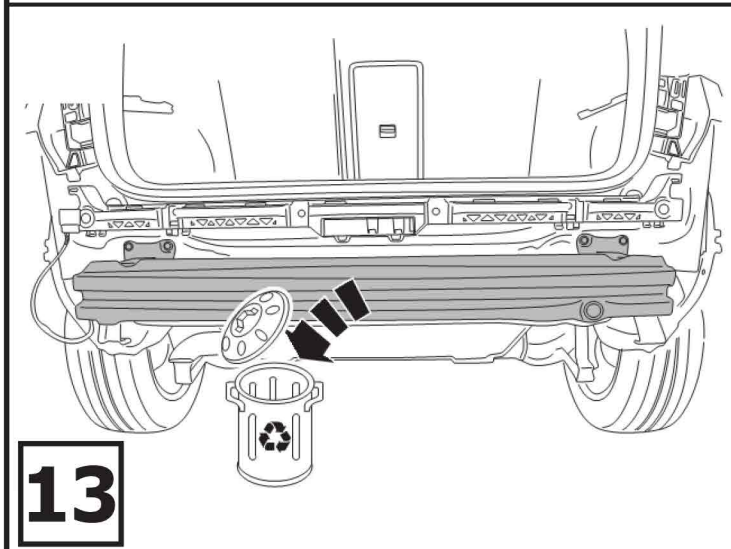
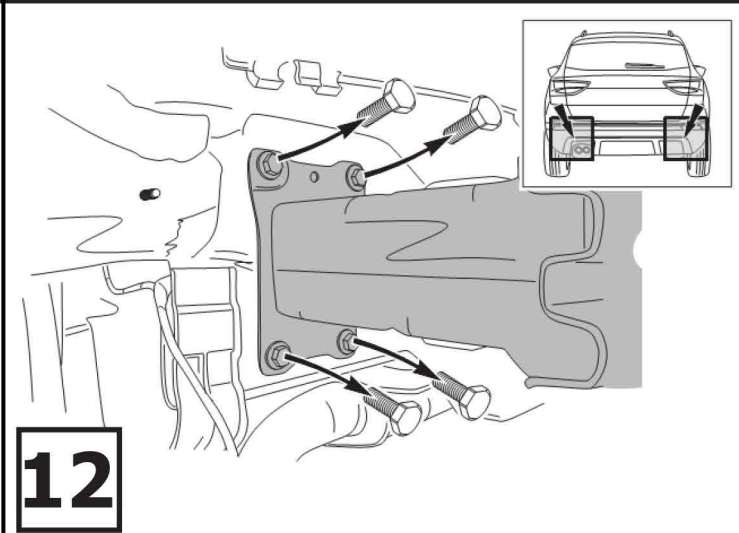
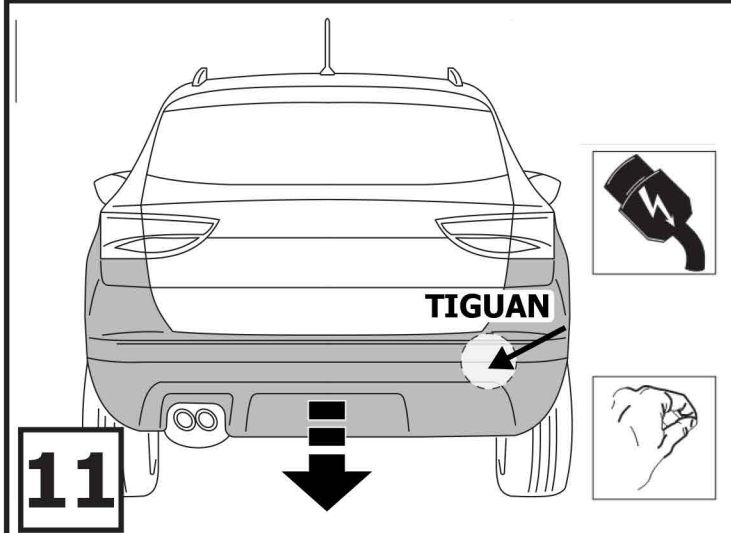
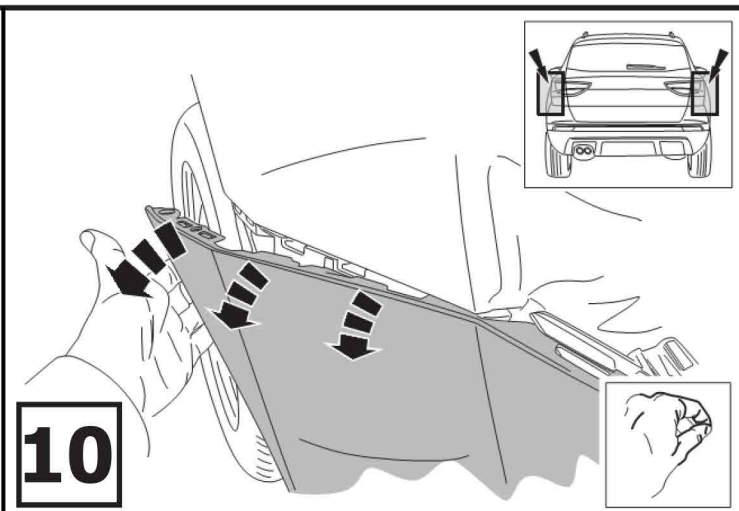
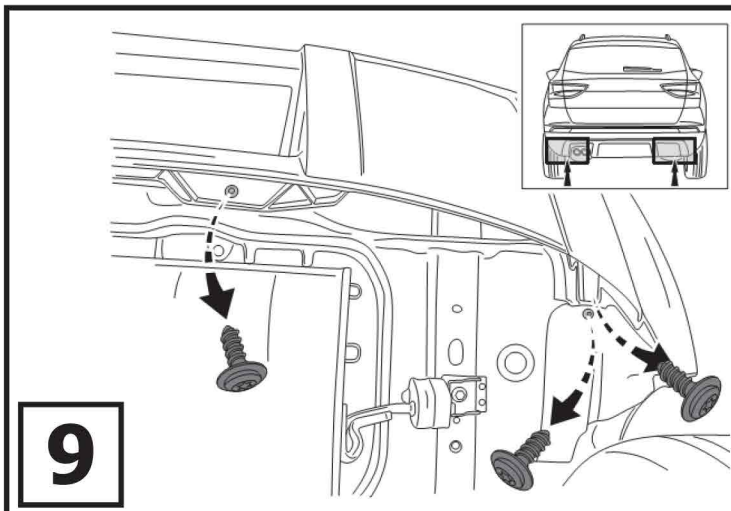

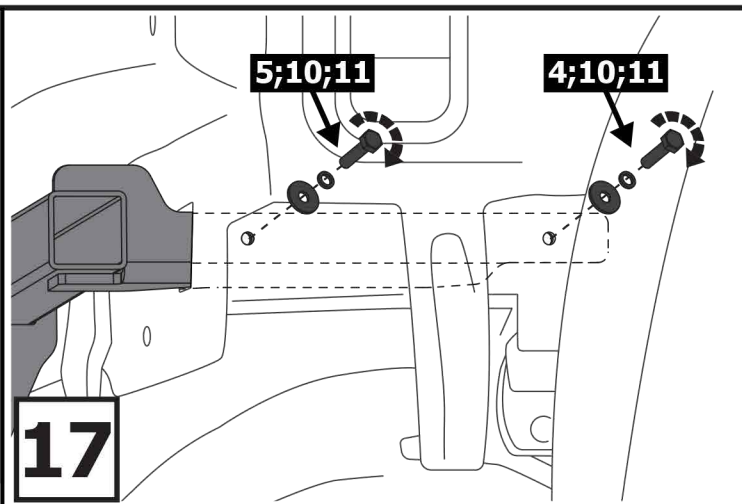
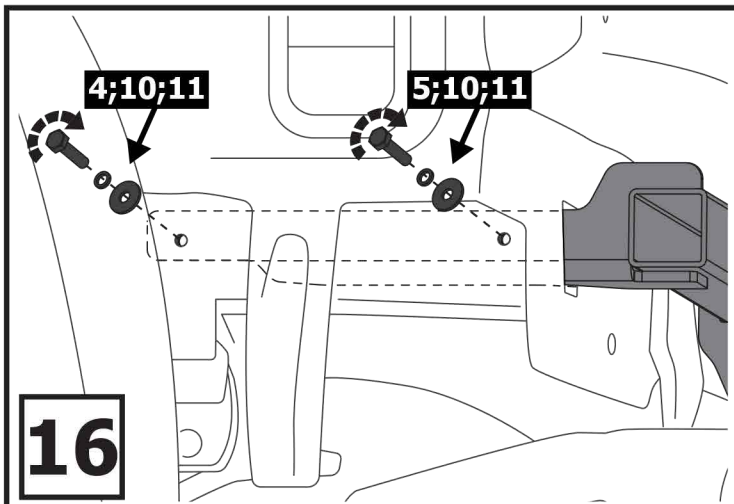

SKODA KAROQ

(2020-)

SKODA KODIAQ

(2017-)

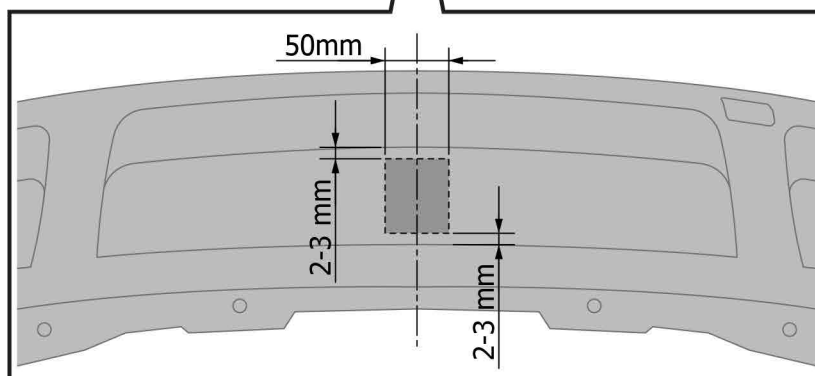
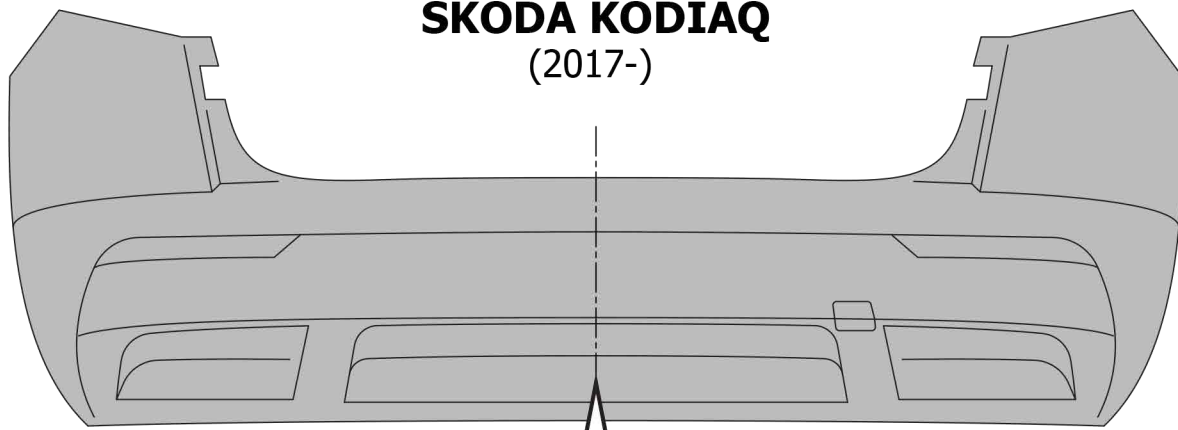

18

